

SERIES G

Adjustable
Deflection
Grilles

PUBLICATION

GRILLES 1

FEB 2007

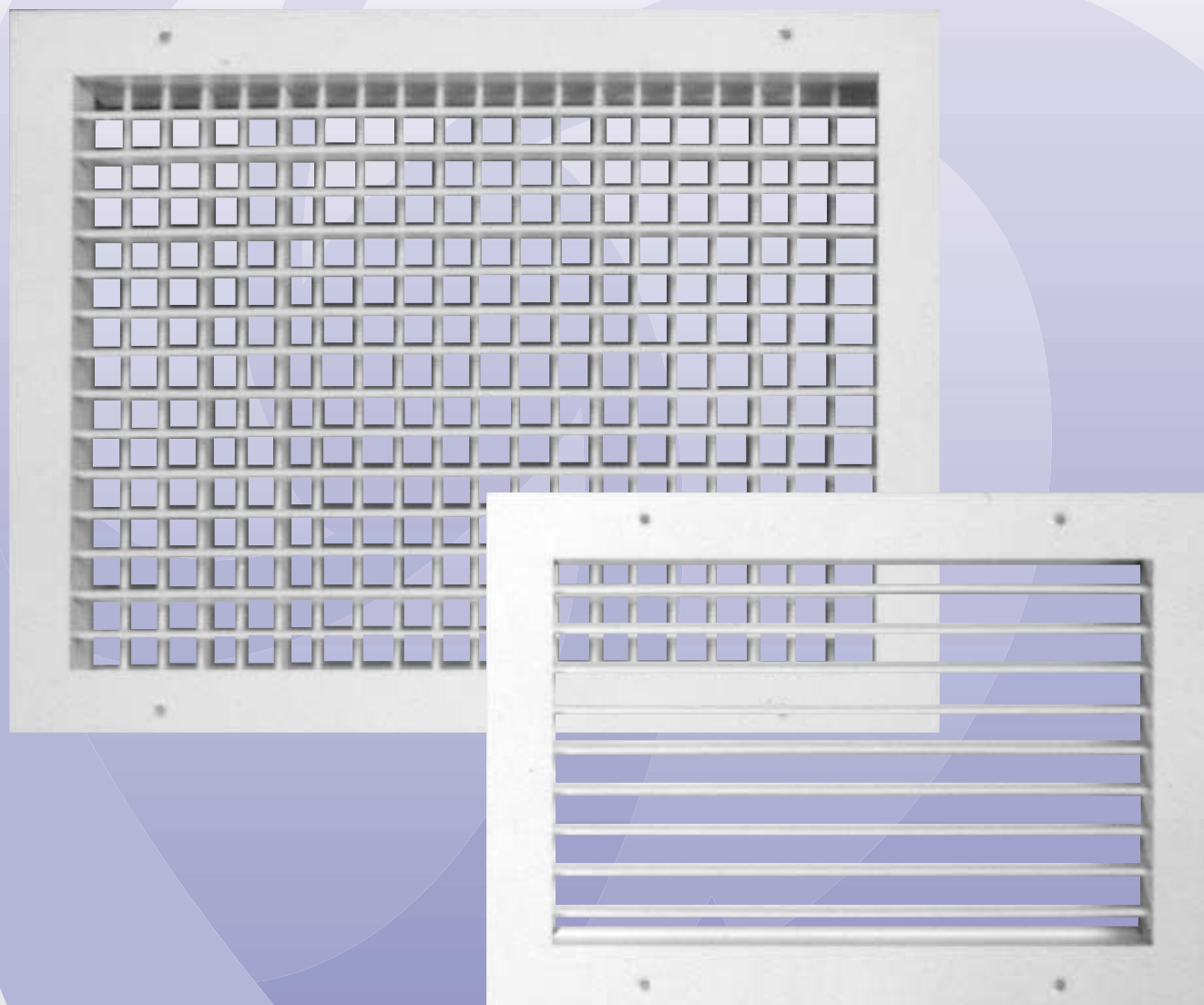

Features

- Single or Double Deflection
- Individually adjustable Blades
- 4mm Aerofoil Section Blade Profile
- Extruded Aluminium Construction



GILBERTS

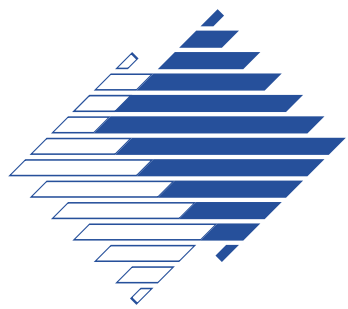

SERIES G

Introduction

Gilberts G Series provides an established and comprehensive range of single and double adjustable deflection grilles for all types of ceiling and sidewall supply and extract application. Comprising of 4mm wide individually adjustable aerofoil blades set on 19mm centres the G Series was designed and is especially suitable, for

standard duty non industrial type applications such as offices, shops and restaurants. Blades are firmly located into a 32mm flange border frame allowing for simple and positive manual blade adjustment and positioning.

Series Options

- Type GH: Single Deflection Grille with one set of horizontal blades.
- Type GV: Single Deflection Grille with one set of vertical blades.
- Type GHV: Double Deflection Grille with horizontal front and vertical rear blades.
- Type GVH: Double Deflection Grille with vertical front and horizontal rear blades.

All units are available complete with screwdriver operated, rear mounted opposed blade volume control damper as well as other accessories such as knob operated dampers and special fixings such as concealed bracket, or quick release.

Standard finish on the G Series is a White Polyester Powder. Other special colours and finishes are available on request.

Features

- Single or Double Deflection
- Individually Adjustable Blades
- 4mm Aerofoil Section Blade Profile
- Extruded Aluminium Construction

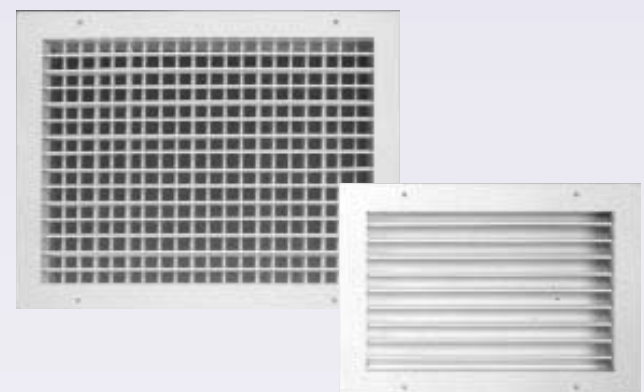

Performance Data

All G Series units can be sized and selected from the nomogram up to a maximum size of 1200 x 1200. All data based on isothermal conditions, dampers fully open.

K factor (free area) on the G Series is approx. 75%

Pressure: All pressures are in Pa (N/m²)
Sound: Measured in average dba level

From the proposed layout and application determine:

1. Volume of air to be handled at each outlet.
2. Throw. To prevent overblow this should be 75% of the distance to the wall opposite or, if the outlets are opposed to one another, this should be one third of the distance between them.
3. Acceptable sound level from chart. Please note that data is only available down to NC20. For selection at lower noise levels please consult with our technical department.
4. Determine the centres of the outlets and, referring to the effective zone chart, establish if deflection is necessary to obtain full coverage of the area served.
5. Temperature differential between primary and secondary air.
6. Mounting Height or outlet.

Example:

Select a suitable supply outlet for a private office 6m x 3m x 3m high, the outlet being located in the centre of the 3m wall. Duty 0.07m³/sec. Throw 4.5m. Acceptable sound level 30db'A'. Cooling temperature differential 6°C. Mounting height 2.75m. referring to the effective zone chart, no deflection is necessary.

Area to be served	Recommended Maximum NC Levels
Sound Broadcasting Recording Studios, TV (Audience Studios)	15 - 20 20 - 25
Lecture Theatres, Cinemas, Concert Halls, Boardroom/Ex Offices Lounge, Conference Room, Court Room, Churches, Private Bedrooms	25 - 30
Operating Theatres, Hospital Wards, Staff Room, Class Rooms, Ballroom, Banquet Room, Library, Bank, Museum, Offices	30 - 40
Restaurants, Department Stores, Computer Suite, Washroom Toilet	35 - 40
Laundries, Kitchens, Swimming Pools, Sports Arena	40 - 45
Garage, Light Engineering Workshop	45 - 50
Heavy Engineering Workshop	50 - 65

From Sizing Nomogram:

A size 300 x 150mm Grille meets the requirements and the sound level is acceptable. Noting the jet velocity refer to the drop assessment chart from which it can be seen that the air-stream does not drop into the occupied zone before the terminal velocity has reached a permissible figure.

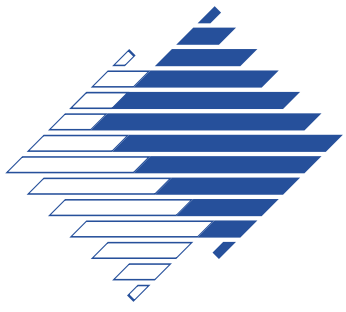

SERIES G

Drop Assessment Chart

A horizontal air stream drops because of two reasons.

1. Discharge velocity and spread (always positive).
2. The temperature differential between the primary air (outlet) and secondary air (room) which is positive for cooling and negative for heating.

EXAMPLE

1. Joining the jet velocity of 2.5m/s to the throw of 3.7metres the drop due to spread is seen to be 0.45m.
2. Taking the point on the pivot line where the line intersects, it can be seen that with a cooling temperature differential of 6° the drop is 0.65m.
3. Total drop
 $0.45 + 0.65 = 1.1\text{m}$

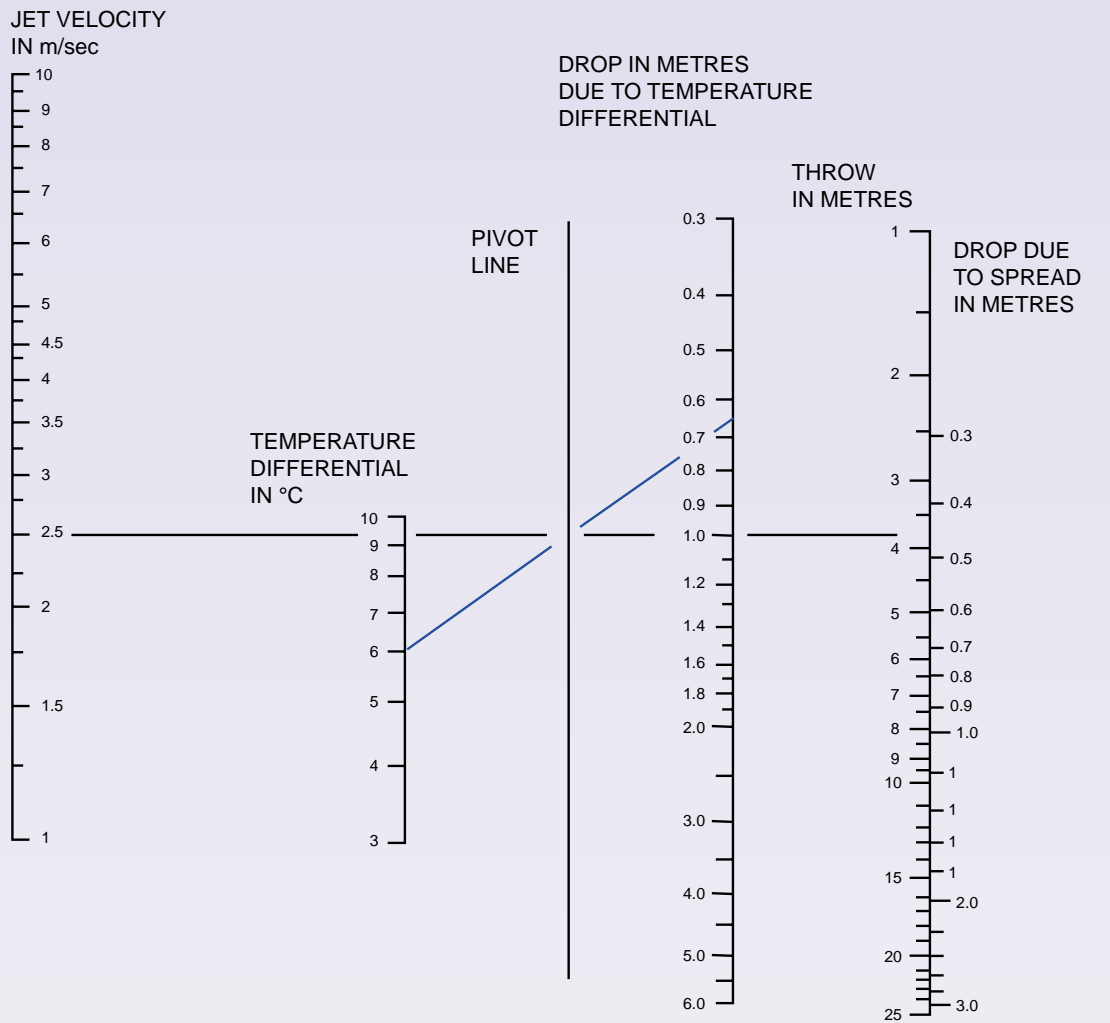

Grille Spread Chart

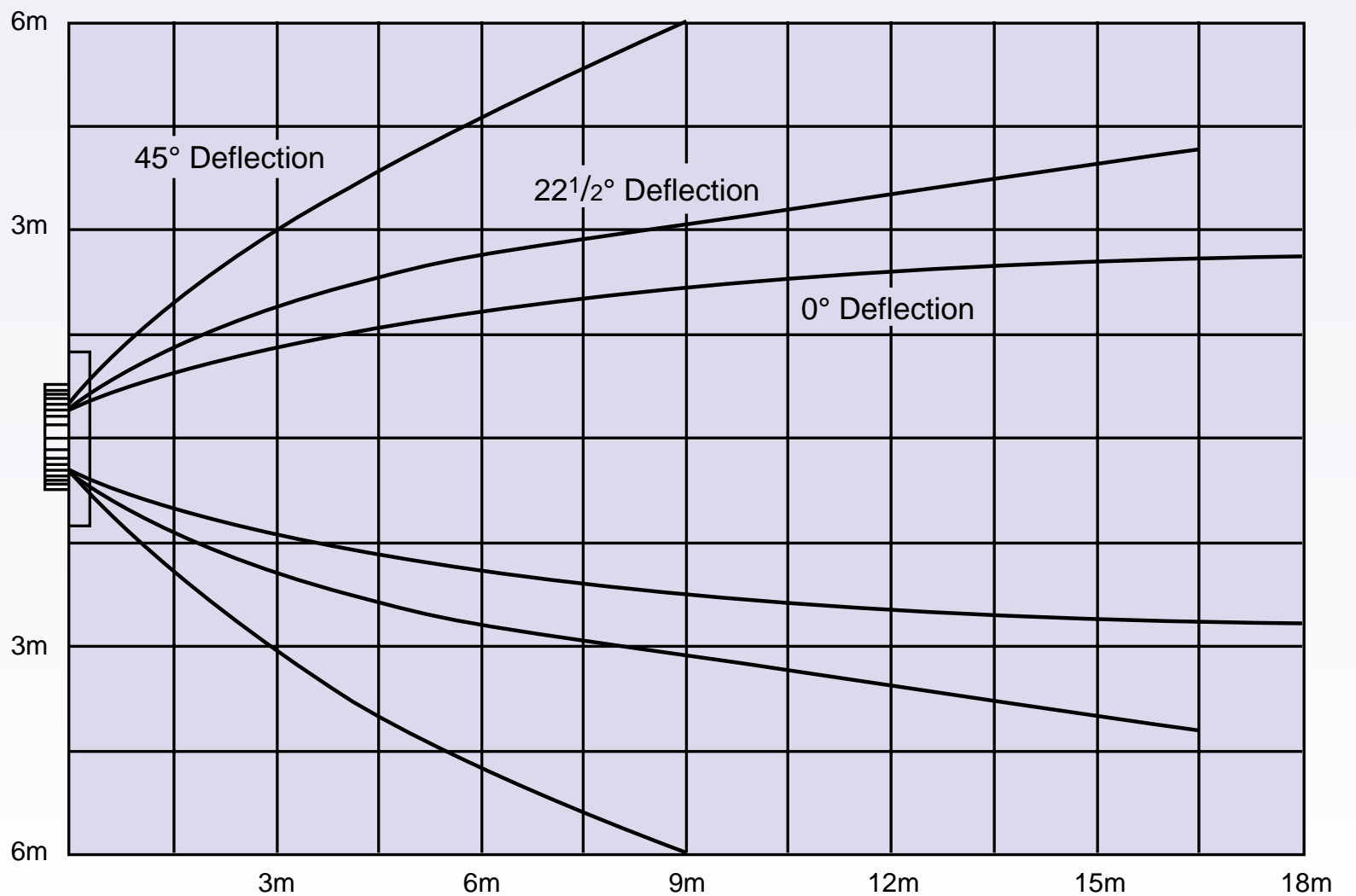



SERIES G

Dimensional Data

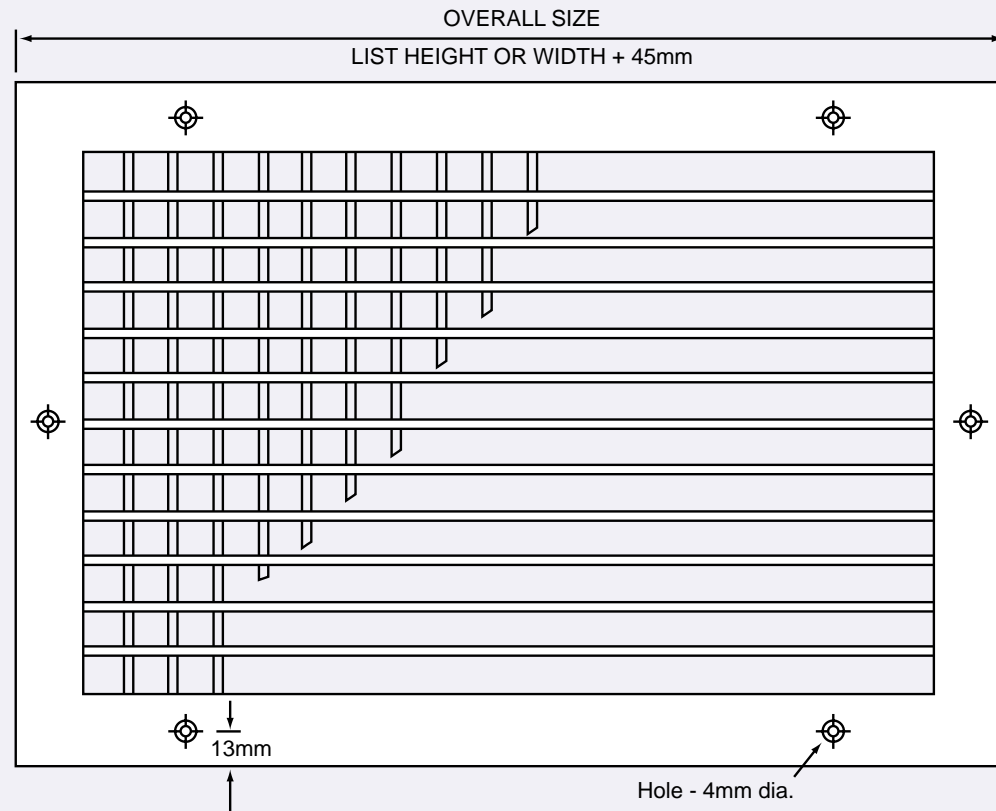

SINGLE DEFLECTION

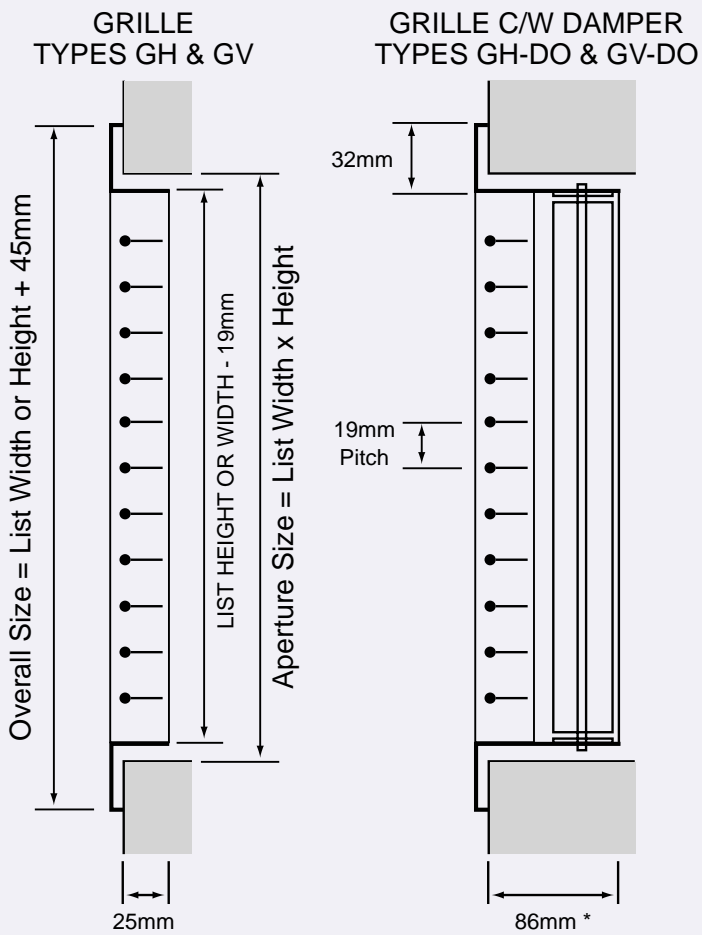

DOUBLE DEFLECTION

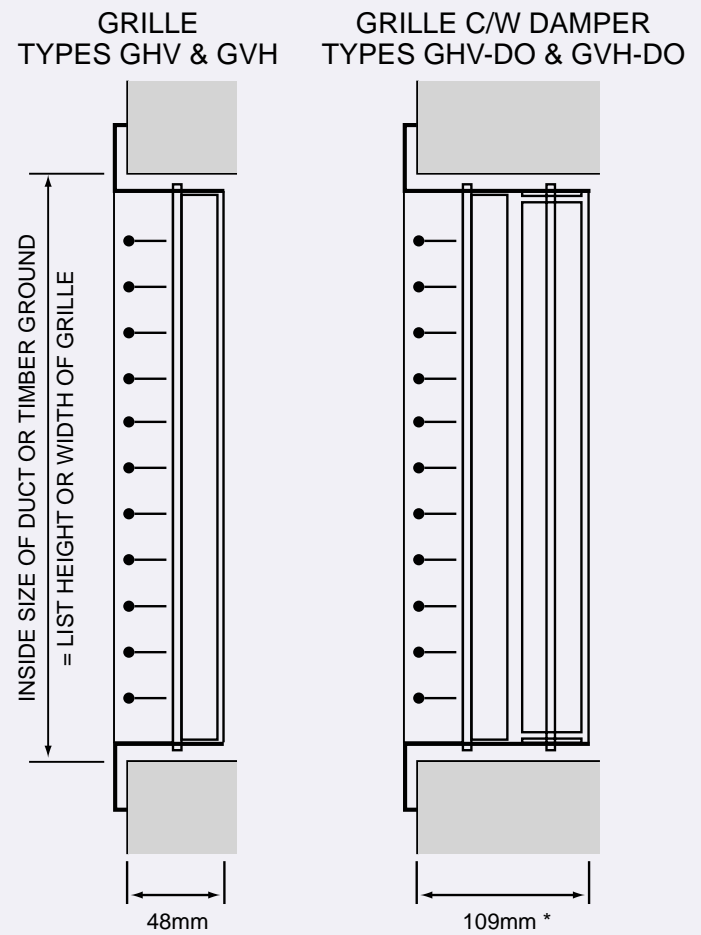

* Max depth - Depth may be lower depending on damper fitment. Please check where necessary.

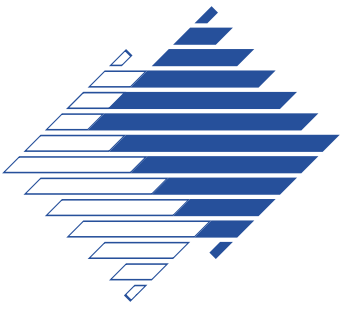

SERIES G

Sizing Nomogram

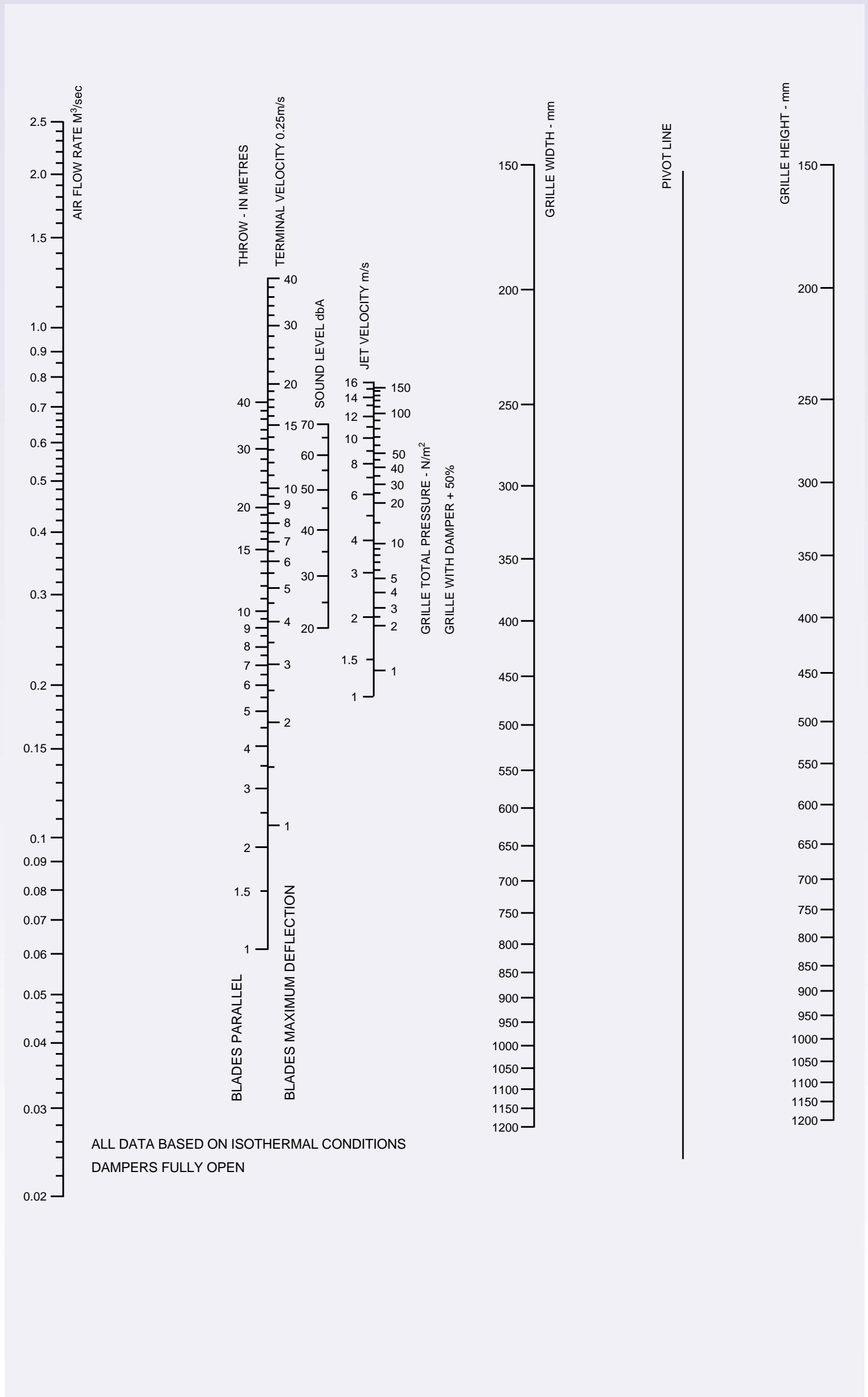

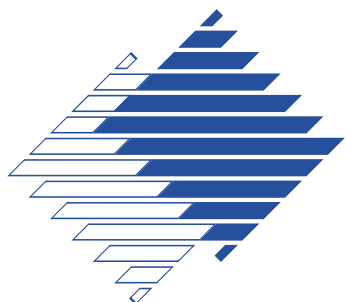

SERIES G

Ordering Specification

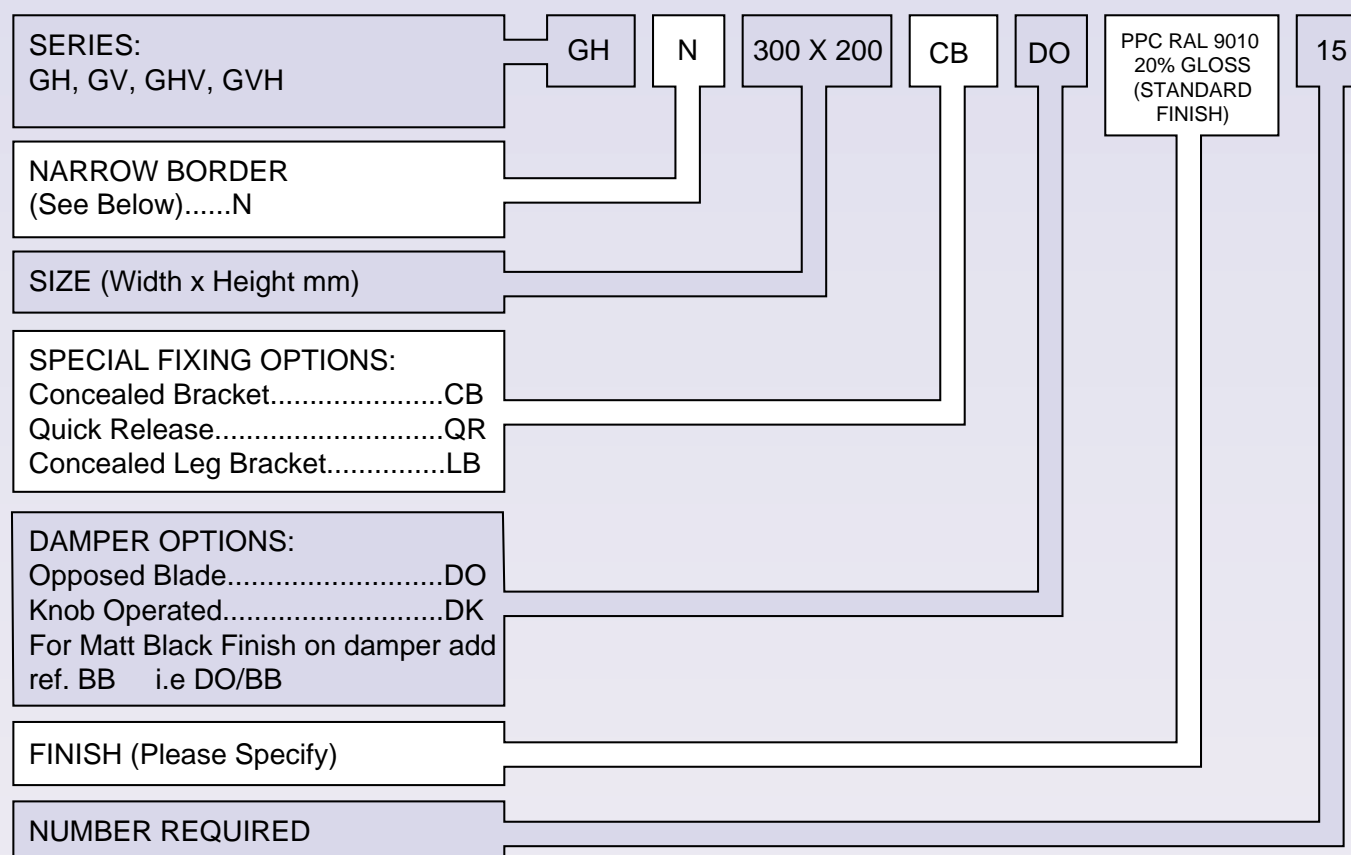

NARROW BORDER

Units can be fitted with narrow 16mm wide flange border instead of the standard 32mm. However, since screw fixing is not possible on a narrow border, a special fixing option must then be selected instead.

FINISH

Standard Finish: Polyester Powder Coat White RAL 9010 20% Gloss.

Special Finishes: Polyester Powder Finish to stock BS or RAL colour.
Stove Enamel Finish to any BS or RAL colour
(Dampers Mill finish Aluminium or Galvanised Steel).

FIXING

Standard flange screw fixing using self tapping screws provided.

SIZE RANGE

Available sizes range from 100 x 100 up to 1200 x 1200, in 1mm increments. For other sizes please contact Head Office.

OPTIONS

Special fixing, border and damper options detailed separately in grille options and accessories data.

Contact

GILBERTS

Head Office and Works
GILBERTS (BLACKPOOL) LTD
Gilair Works, Clifton Road,
Blackpool.
Lancashire FY4 4QT.
Telephone: (01253) 766911
Fax: (01253) 767941
e-mail: sales@gilbertsblackpool.com
Web: www.gilbertsblackpool.com

